

PRODUCT DETAILS

The DAB JINOX132M is a composite, self-priming centrifugal pressure pump with excellent suction capacity even when there are air bubbles in the water.

Particularly suited to water supply in domestic installations, small-scale agriculture, gardening and wherever self-priming operation is required.

DAB Jinox pumps are renowned for their unique self priming and extraordinary deep suction capability; up to 8 metres at sea level.



APPLICATIONS

- Household water supply - large dwellings
- Light garden irrigation
- Water transfer
- Washing systems
- Pressure boosting

FEATURES

- Motor support in cast iron, technopolymer pump body, impeller, diffuser, Venturi tube and sand guard. Stainless steel adjustment rings and pump body
- Carbon/ceramic mechanical seal.
- Asynchronous motor closed and cooled by external ventilation. Max Ambient temp 40 deg C
- Built-in thermal and current overload protection and a capacitor permanently on in the single-phase versions.

TECHNICAL DATA

OUTPUT POWER (KW)	1.0kW P2
MAX. HEAD [M]	48M
MAX. FLOW L/MIN	80 l/min
MAX PRESSURE	6 bar
LIQUID TEMPERATURE	2 - 35 deg C
MOTOR	Asynchronous TEFC
MOTOR INSULATION	F Class insulation
MOTOR PROTECTION	In-built thermal overload
PROTECTION CLASS	IP44. Terminal board I.P.55

RATED VOLTAGE	220 - 240V 1Ph 50 Hz
RATED CURRENT	6.6A
CAPACITOR	25uF 450V
POWER CABLE	2m long 10 amp rated H05 flex 10 amp 3 pin plug
PUMP BODY	AISI 304 X5 Cr Ni 1810 UNI 6900/71
INTERNALS	Technopolymer A
MECHANICAL SEAL	Carbon/Ceramic
PACKAGE DIMENSION	L470 x W240 x H240mm
GROSS WEIGHT (KG)	11.0kg

CURVE

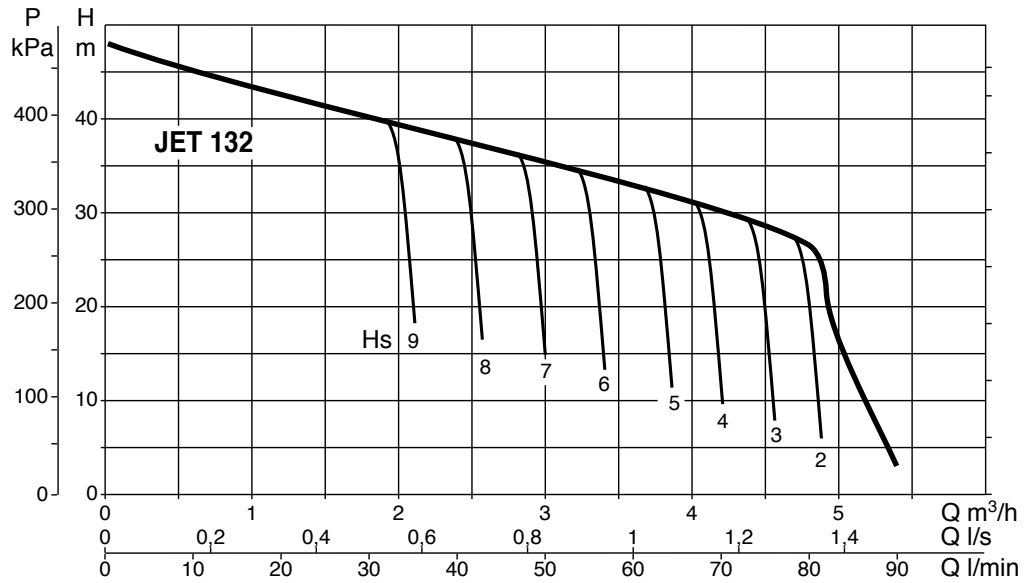

DIMENSIONS

A	425
B	170
C	122
E	208
F	14
G	111
H	203
H2	144
I	Dia 9
DNA	1" GAS
DNM	1" GAS

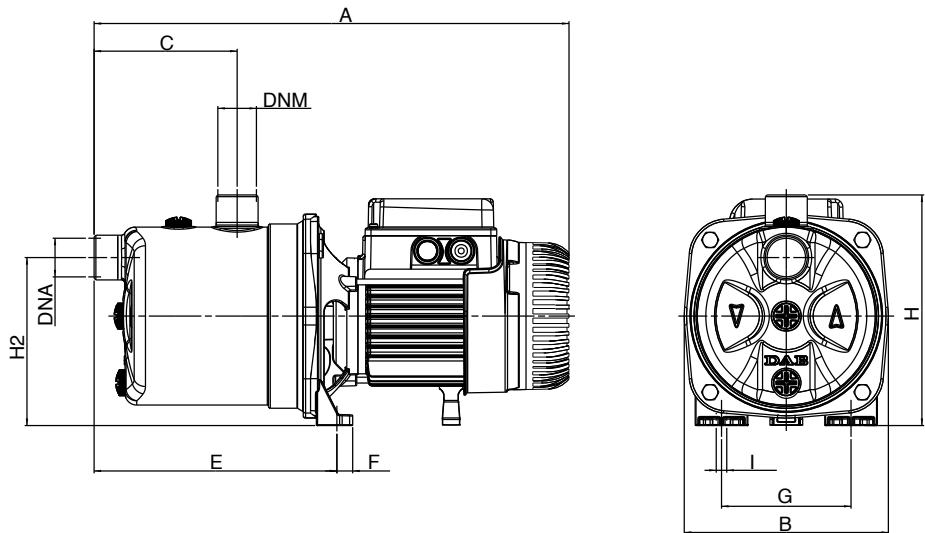

WARRANTY / CERTIFICATIONS

